

PLANK[®]

PRODUCT MANUAL
BEDIENUNGSANLEITUNG
MANUALE DEL PRODOTTO



MART TABLE
RECTANGULAR | RECHTECKIG | RETANGOLARE
MOD. 9820 | 9825



ASSEMBLY | MONTAGE | MONTAGGIO

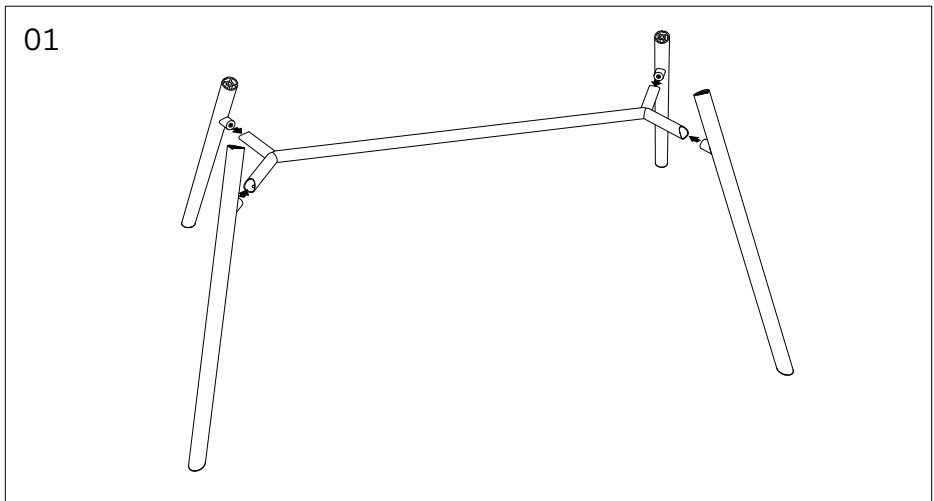

02

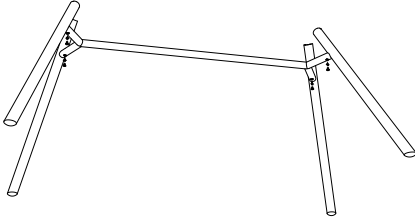
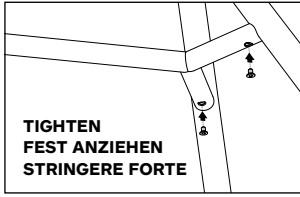

03

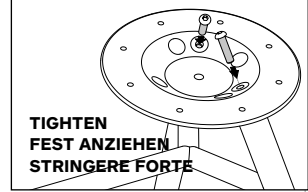
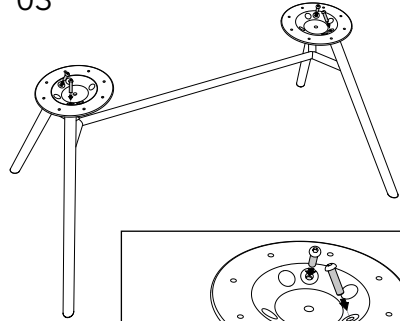

04

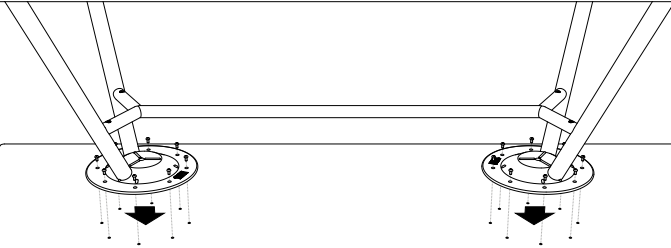

05

TIGHTEN
FEST ANZIEHEN
STRINGERE FORTE

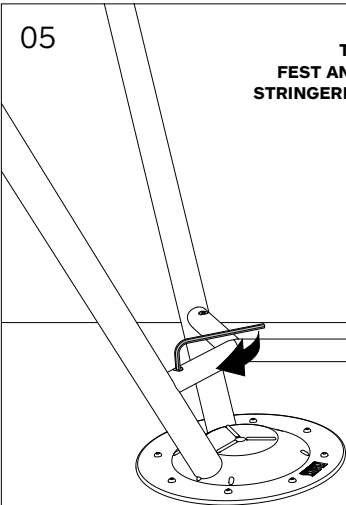

06

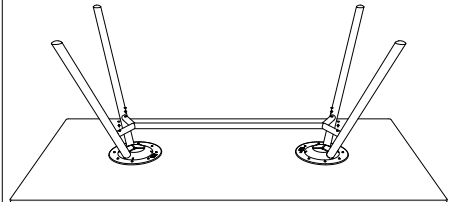
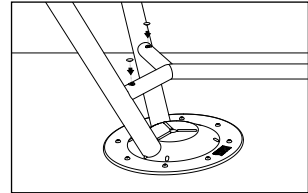

GENERAL INSTRUCTIONS
ALLGEMEINE GEBRAUCHSHINWEISE
ISTRUZIONI GENERALI



SCAN ME _

Plank Srl
Via Nazionale 35
I-3940 Ora (BZ)
Tel +39 0471 803 500
info@plank.it
www.plank.it

Quality system according to ISO 9001
© 2025 Plank Srl - All Products International Deposit of Industrial Design