

PLANK®

MIURA table design Konstantin Grcic



MIURA table extended base design Konstantin Grcic



Sistema di tavolo pieghevole, struttura in alluminio verniciato a polvere o alluminio lucido, piani in acciaio, MDF o HPL Full color nei colori nero e bianco, (piani in metallo anche in rosso). Piano tavolo ribaltabile. Uso interno ed esterno.

Table system, structure in powder coated aluminium or polished aluminium, top in powder coated metal, MDF or HPL Full color in black and white, (metal tops also in red). With folding table top. Indoor and outdoor use.

Tisch System, Gestell in pulverbeschichtetem Aluminium oder in poliertem Aluminium, Platte in Metall, MDF oder Vollaminat HPL in den Farben schwarz und weiß, (Metallplatten auch in verkehrsrot). Tischplatte klappbar. Innen- und Außenbereich.

Finiture tavolo / Table Finishings / Tischausführungen
Piano in metallo / metal table top / Metalltischplatte (Mod. 9553)
MDF verniciato / powder coated / pulverbeschichtet
HPL - Full color

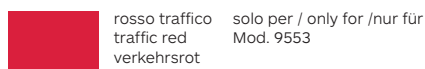
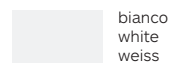
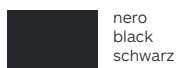

MIURA table design Konstantin Grcic

Mod. 9553-51

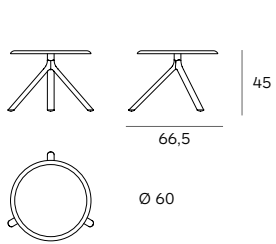

Mod. 9553-01

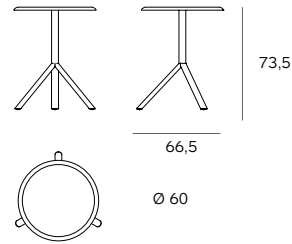

Mod. 9553-71

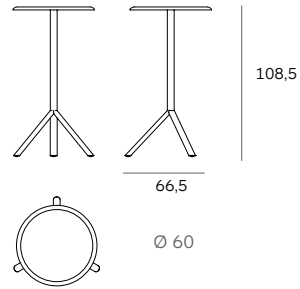

Mod. 9590-51 (Ø 70)

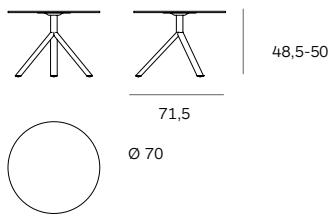

Mod. 9590-01 (Ø 70)
Mod. 9591-01 (Ø 80)
Mod. 9592-01 (Ø 90)

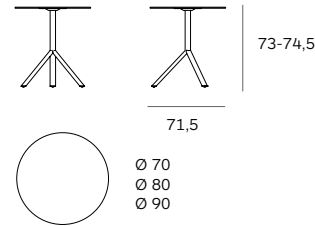

Mod. 9590-71 (Ø 70)
Mod. 9591-71 (Ø 80)

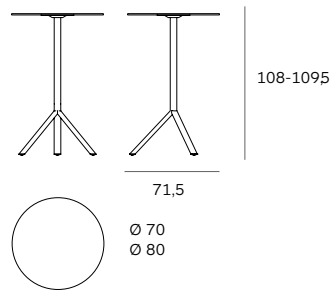

Mod. 9580-51

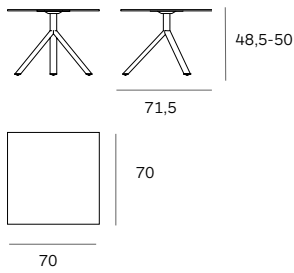

Mod. 9580-01

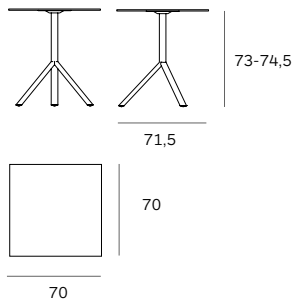

Mod. 9580-71

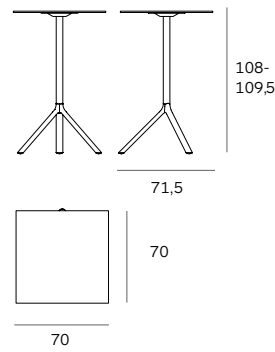

Mod. 9555-71 (Ø 100)
Mod. 9556-71 (Ø 110)

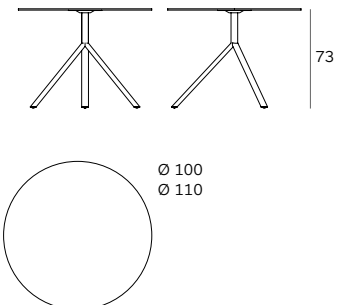

MIURA table extended base design Konstantin Grcic

Mod. 9586-01

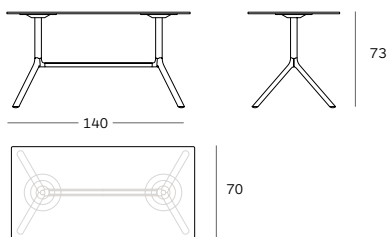

Mod. 9586-71

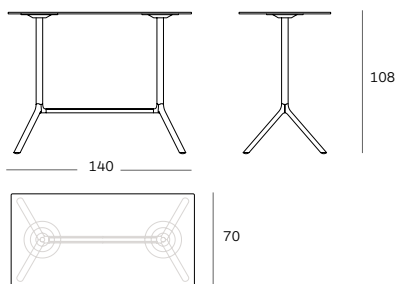

Mod. 9587-01

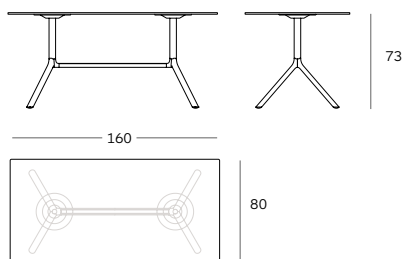

Mod. 9587-71

